



HELIX2-LED240

Performance Area Light



Slipfitter



Yoke



Trunnion



Direct mount for round/square poles



House Side Cut Off Shield

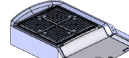

Side Cut Off Shield

IDEAL APPLICATIONS

- Parking Lots
- Schools
- Dealerships
- Commercial Plazas
- Roadway Lighting

DESCRIPTION:

The HELIX-LED Series are performance area lights available in T2, T3, T4 or T5 optics ideal for a wide range of applications including commercial and retail parking lots, car dealerships, and roadway lighting.

FEATURES:

- Die cast aluminum housing with polycarbonate lens.
- Tool less entry to access driver/wiring compartment. 1m cab tire cable included for external wiring.
- Universal mounting with options for Slip Fitter, Yoke, Trunnion, Direct Mount for round and square poles. Purchase mounting option separately.
- Fixture can be tilted with any mounting option to direct light where needed.
- Options for lighting controls include 7 PIN receptacle for smart control, twist lock photocell, and motion sensor with remote control.
- 10kV surge protection built into the driver.
- High performance optics designed for zero uplight (U0).
- House cut off (HCO) and Side cut off (SCO) are optional. Housing will come with pre-drilled holes and cut off shield (HCO/SCO) can be installed in the field using supplied hardware.
- Rotating optics in 90° segments to redirect light in any direction (factory installed)

SPECIFICATIONS*

HELIX2-LED240

Watts	241W
Lumens	35175 Lm
Efficacy	143 Lm/W
Voltage	120-277V*, 347V
Colour Temp	3000K/4000K*/5000K*
CRI	70
Dimming	1-10V*, 0-10V Dimming
THD	<15%
PF	0.9
Beam Distribution	T2,T3*,T4,T5
LED Life (L80)	100,000 hours
Housing Finish	Bronze*, Custom Colours
Housing Details	Die Cast Aluminum
Lens Details	Clear Polycarbonate Lens
Mounting	Slip fitter, Direct mount for round/square poles, Trunnion mount, Yoke mount
Cable Length	Input Power - 1m Cab Tire Cable (SOOW 3x18 AWG) Dimming - 1m Cab Tire Cable (SJOW 2x18 AWG)
Operating Temp.	-40°C to +50°C
Factory Installed Options	PIR Motion Sensor with Optional Dusk to Dawn Function, Twist Lock Photocell, 7 PIN Receptacle with Shorting Cap ANSI C136. 41-2013 compliant
Options Sold Separately	Slip fitter, Direct mount for round/square poles, Trunnion mount, Yoke mount, Motion sensor remote control
Certifications Logos	cULus, Wet Location, IP65, DLC Premium

*Above specifications are for 120-277V/5K configuration. See Page 7 for specifications of other configurations



Rotatable Optics



COLOUR OPTIONS

Standard Colours



bronze
195632 / GS512M17



matte black
103848 / 39/80020



black sandtex
(textured)
194288 / P-2128-LT



mirror black
(shiny)
103849 / PS111N9

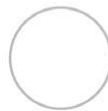

white
103847 / P-1771-9



dove grey
000047 / SCP-409



blue
103865 / SCP-910



red
103866 / P-6015-8



yellow
195585 / RAL 1018 (TIGER)



green
103864 / SCP-651



garden green
194070 /
TD01032-F-FILE#116P6

Metallic Colours



hammertone
194290 /
TGIC DCL#5980-0799-MMI



sparkle silver
194260 / PM211511

Custom Colours



AMPERAGE DRAW & SURGE PROTECTION							
	CURRENT (A)					SURGE PROTECTION (kV)	
	120V	208V	240V	277V	347V	120-277V	347V
HELIX2-LED	1.32A	0.76A	0.66A	0.57A	0.46A	10kV	10kV

TM-21 ESTIMATED LUMEN MAINTENANCE			
	50,000 Hours	75,000 Hours	100,000 Hours
HELIX2-LED	90.1%	85.5%	81.0%

EPA (ft ²)			
	0° Tilt	45° Tilt	90° Tilt
HELIX2-LED	0.64	2.46	3.14

WEIGHT (lbs)	
HELIX2-LED	20.5

HELIX 2 NO MOUNT

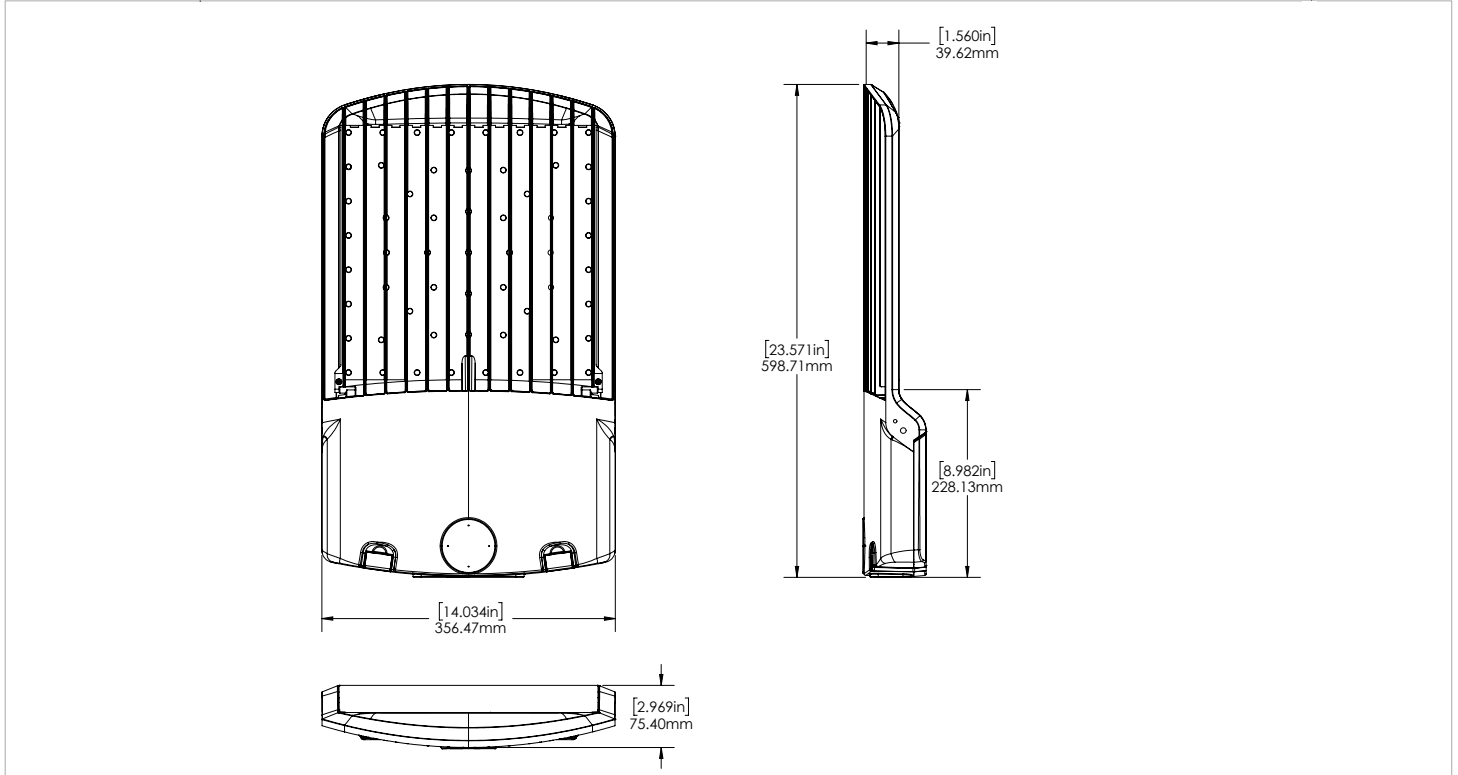

HELIX 2 DIRECT MOUNT

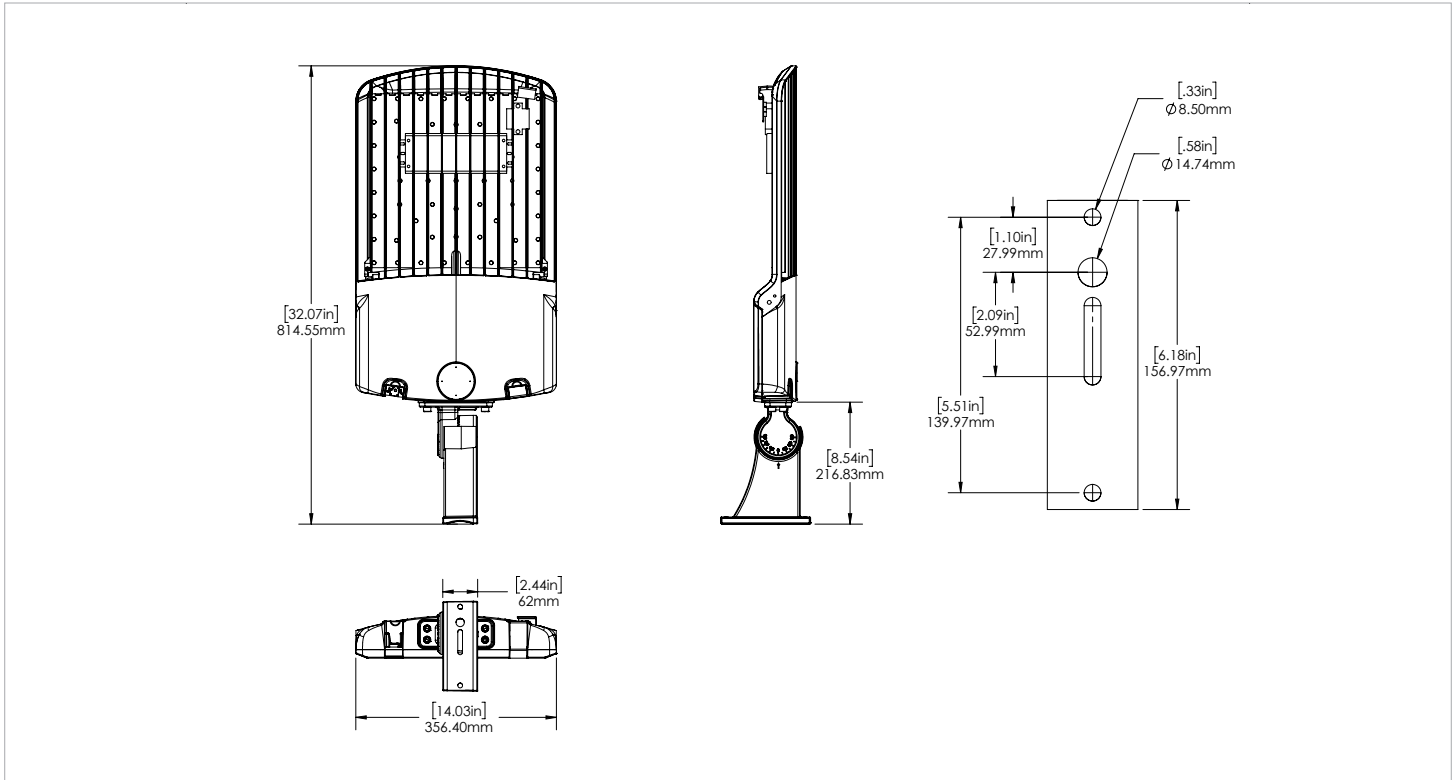

HELIX 2 TRUNNION

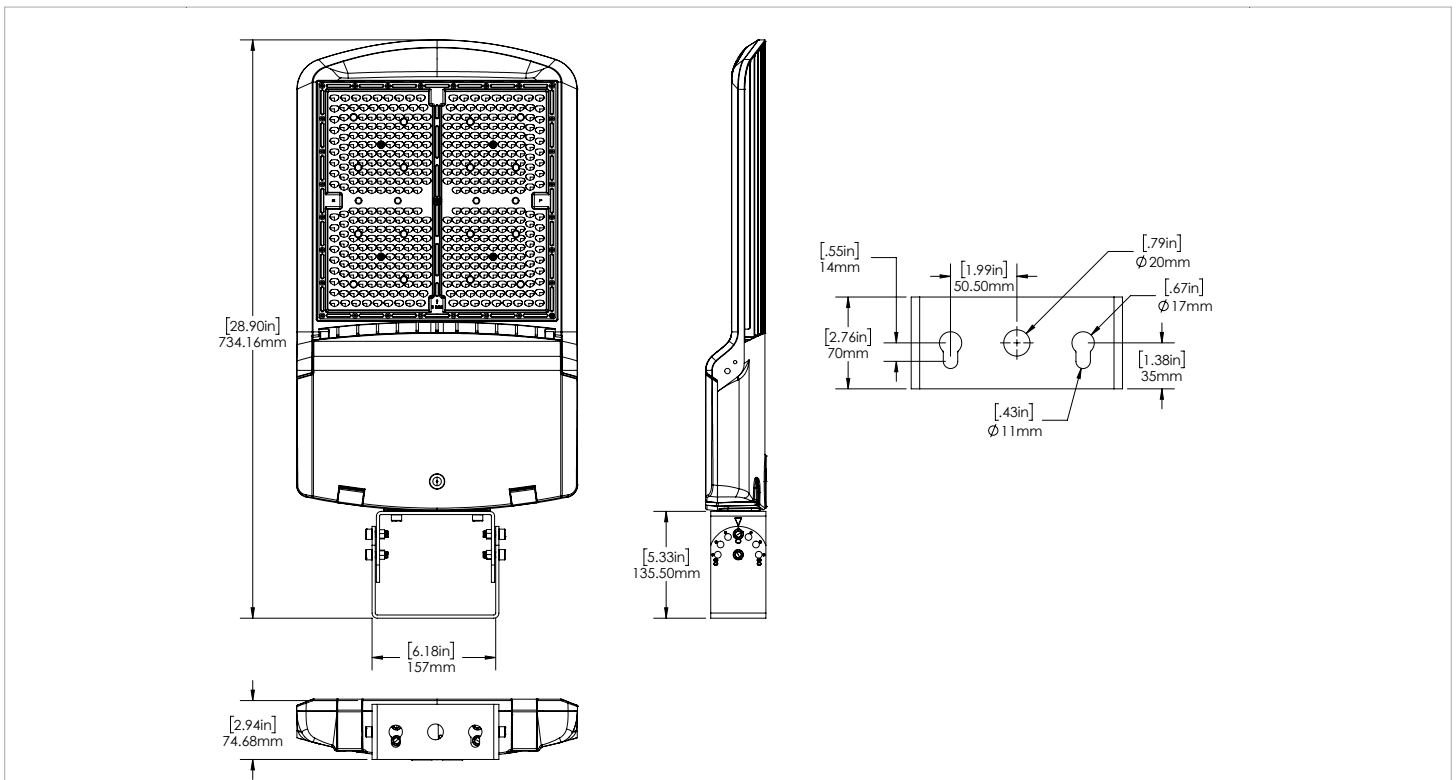

HELIX 2 YOKE MOUNT

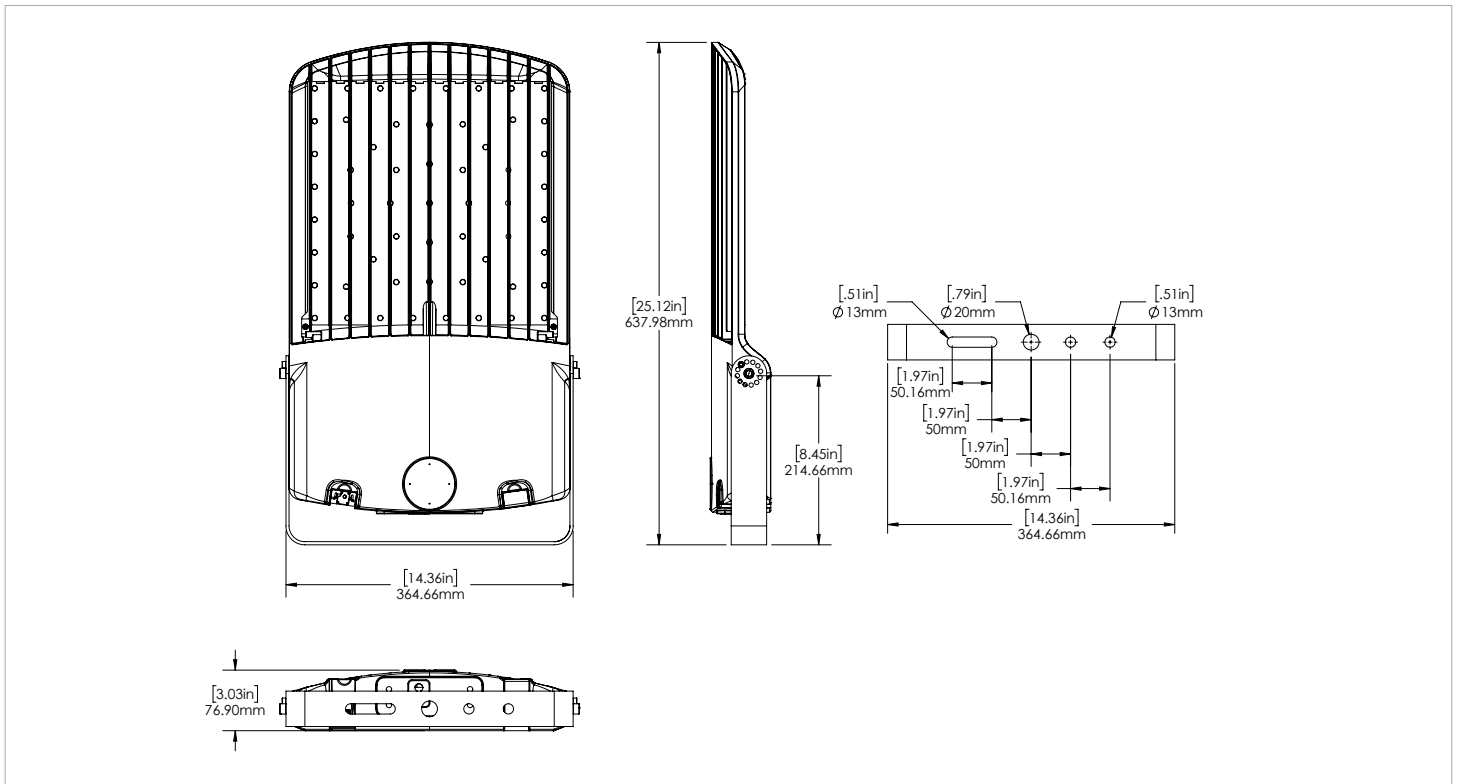

HELIX 2 WITH HOUSE CUTOFF (HCO)

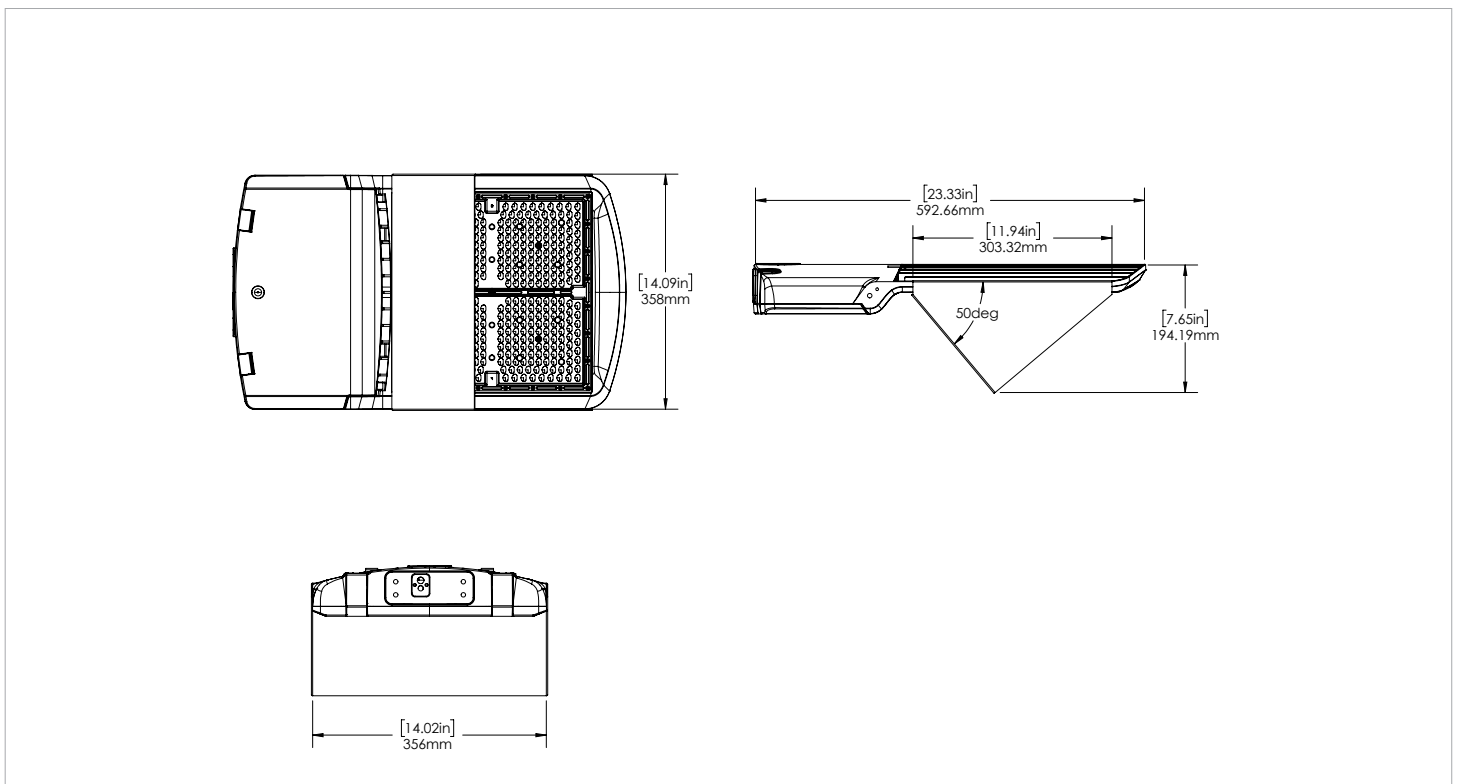

HELIX 2 WITH SIDE CUTOFF (SCO)

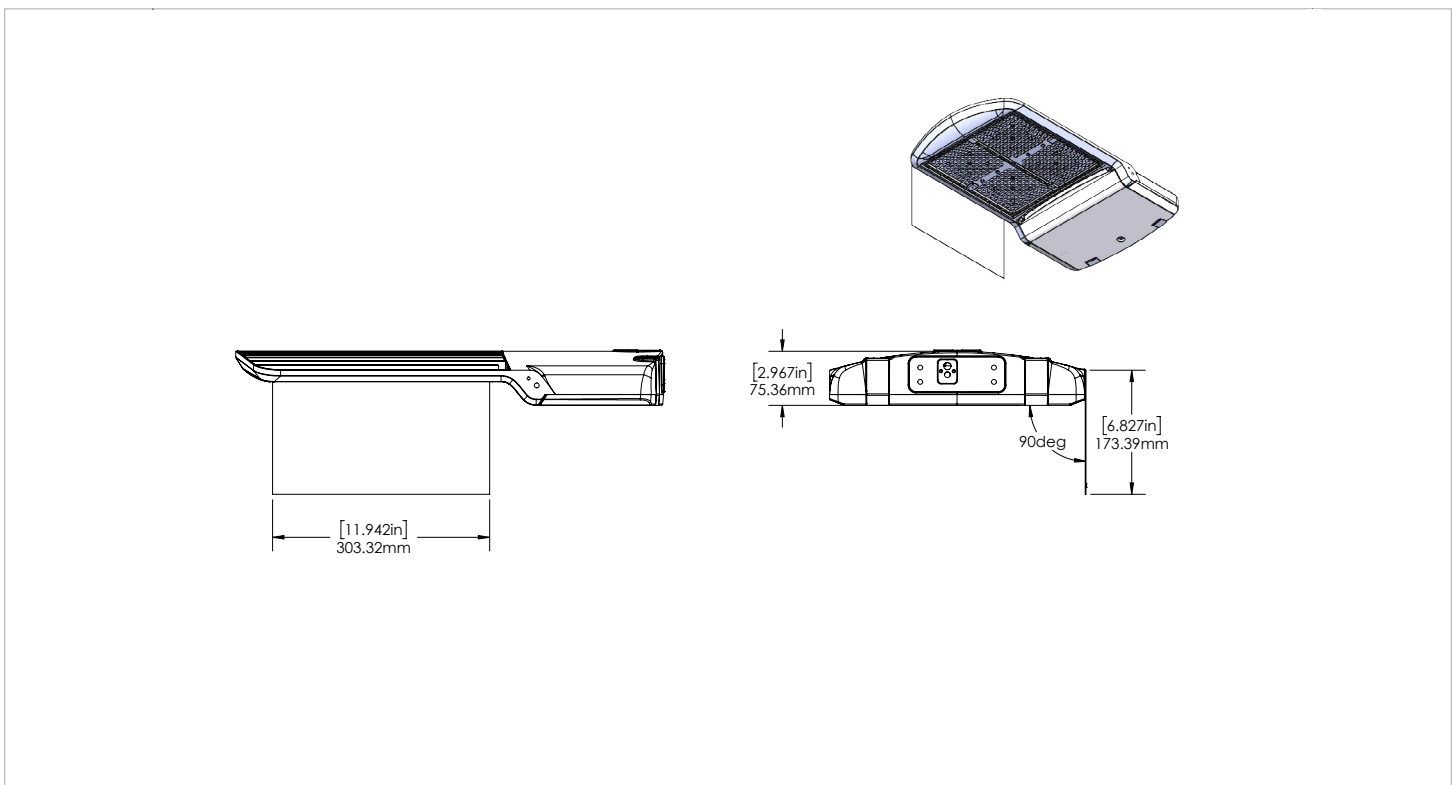

SPECIFICATIONS

Model Number	Voltage (V)	Power (W)	Light Output (lm)	Efficacy (lm/W)	THD (%)	PF	CCT (K)	B-U-G
HELIX2-LED240-B-3K-T2-XXX-DIM-[Blank, DMS, PC, 7PIN]	120-277	241	34462	143.0	15.0	0.900	3000	4-0-4
HELIX2-LED240-B-4K-T2-XXX-DIM-[Blank, DMS, PC, 7PIN]	120-277	241	34601	143.7	15.0	0.900	4000	4-0-4
HELIX2-LED240-B-5K-T2-XXX-DIM-[Blank, DMS, PC, 7PIN]	120-277	241	34877	144.9	15.0	0.900	5000	4-0-4
HELIX2-LED240-C-3K-T2-XXX-DIM-[Blank, DMS, PC, 7PIN]	347	232	34263	147.8	15.0	0.900	3000	4-0-4
HELIX2-LED240-C-4K-T2-XXX-DIM-[Blank, DMS, PC, 7PIN]	347	231	34382	148.7	15.0	0.900	4000	4-0-4
HELIX2-LED240-C-5K-T2-XXX-DIM-[Blank, DMS, PC, 7PIN]	347	231	34620	149.8	15.0	0.900	5000	4-0-4
HELIX2-LED240-B-3K-T3-XXX-DIM-[Blank, DMS, PC, 7PIN]	120-277	241	35006	145.3	15.0	0.900	3000	4-0-4
HELIX2-LED240-B-4K-T3-XXX-DIM-[Blank, DMS, PC, 7PIN]	120-277	241	35175	146.1	15.0	0.900	4000	4-0-4
HELIX2-LED240-B-5K-T3-XXX-DIM-[Blank, DMS, PC, 7PIN]	120-277	241	35511	147.5	15.0	0.900	5000	4-0-4
HELIX2-LED240-C-3K-T3-XXX-DIM-[Blank, DMS, PC, 7PIN]	347	231	34544	149.3	15.0	0.900	3000	4-0-4
HELIX2-LED240-C-4K-T3-XXX-DIM-[Blank, DMS, PC, 7PIN]	347	231	34681	150.1	15.0	0.900	4000	4-0-4
HELIX2-LED240-C-5K-T3-XXX-DIM-[Blank, DMS, PC, 7PIN]	347	231	34953	151.3	15.0	0.900	5000	4-0-4
HELIX2-LED240-B-3K-T4-XXX-DIM-[Blank, DMS, PC, 7PIN]	120-277	241	34169	141.6	15.0	0.900	3000	4-0-5
HELIX2-LED240-B-4K-T4-XXX-DIM-[Blank, DMS, PC, 7PIN]	120-277	241	34355	142.3	15.0	0.900	4000	4-0-5
HELIX2-LED240-B-5K-T4-XXX-DIM-[Blank, DMS, PC, 7PIN]	120-277	241	34725	143.8	15.0	0.900	5000	4-0-5
HELIX2-LED240-C-3K-T4-XXX-DIM-[Blank, DMS, PC, 7PIN]	347	231	34097	147.9	15.0	0.900	3000	4-0-5
HELIX2-LED240-C-4K-T4-XXX-DIM-[Blank, DMS, PC, 7PIN]	347	231	34256	148.4	15.0	0.900	4000	4-0-5
HELIX2-LED240-C-5K-T4-XXX-DIM-[Blank, DMS, PC, 7PIN]	347	231	34572	149.8	15.0	0.900	5000	4-0-5
HELIX2-LED240-B-3K-T5-XXX-DIM-[Blank, DMS, PC, 7PIN]	120-277	241	32595	135.2	15.0	0.900	3000	5-0-5
HELIX2-LED240-B-4K-T5-XXX-DIM-[Blank, DMS, PC, 7PIN]	120-277	241	32785	136.3	15.0	0.900	4000	5-0-5
HELIX2-LED240-B-5K-T5-XXX-DIM-[Blank, DMS, PC, 7PIN]	120-277	241	33166	137.9	15.0	0.900	5000	5-0-5
HELIX2-LED240-C-3K-T5-XXX-DIM-[Blank, DMS, PC, 7PIN]	347	232	32224	139.1	15.0	0.900	3000	5-0-5
HELIX2-LED240-C-4K-T5-XXX-DIM-[Blank, DMS, PC, 7PIN]	347	231	32351	140.0	15.0	0.900	4000	5-0-5
HELIX2-LED240-C-5K-T5-XXX-DIM-[Blank, DMS, PC, 7PIN]	347	231	32603	141.1	15.0	0.900	5000	5-0-5

LEGEND

B-120-277V, C-347V
 3K-3000K, 4K-4000K, 5K-5000K
 T2-Type II, T3-Type III, T4-Type IV, T5-Type V
 XXX - Housing Finish
 DIM - 1-10V Dimming for 120-277V, 0-10V Dimming for 347V
 DMS - Dimming motion Sensor
 PC - Photocell

BRI810/BRI820 SENSOR SPECIFICATIONS

DHFS SENSOR SPECIFICATIONS	
POWER SUPPLY	100-347 VAC, SINGLE PHASE, 60HZ
HIGH FREQUENCY SYSTEM	5.8GHZ +/-75MHZ
DIM CONTROL OUTPUT	0-10V DC DIMMING, 25MA
DETECTION RADIUS/ANGLE	MAX 8M (26FT) AT 360°
MOUNTING HEIGHT	PIR: MAX 15M (50FT)
HUMIDITY	MAX 95% RELATIVE HUMIDITY
OPERATING TEMP.	-40°C TO +70°C
CYCLES	200,000 ON/OFF CYCLES
CERTIFICATIONS	CRUUS, FCC
PROGRAMMING	WIRELESS PROGRAMMING USING RC-100 REMOTE

LIGHTS DETECTION RANGE & RADIUS/ANGLE

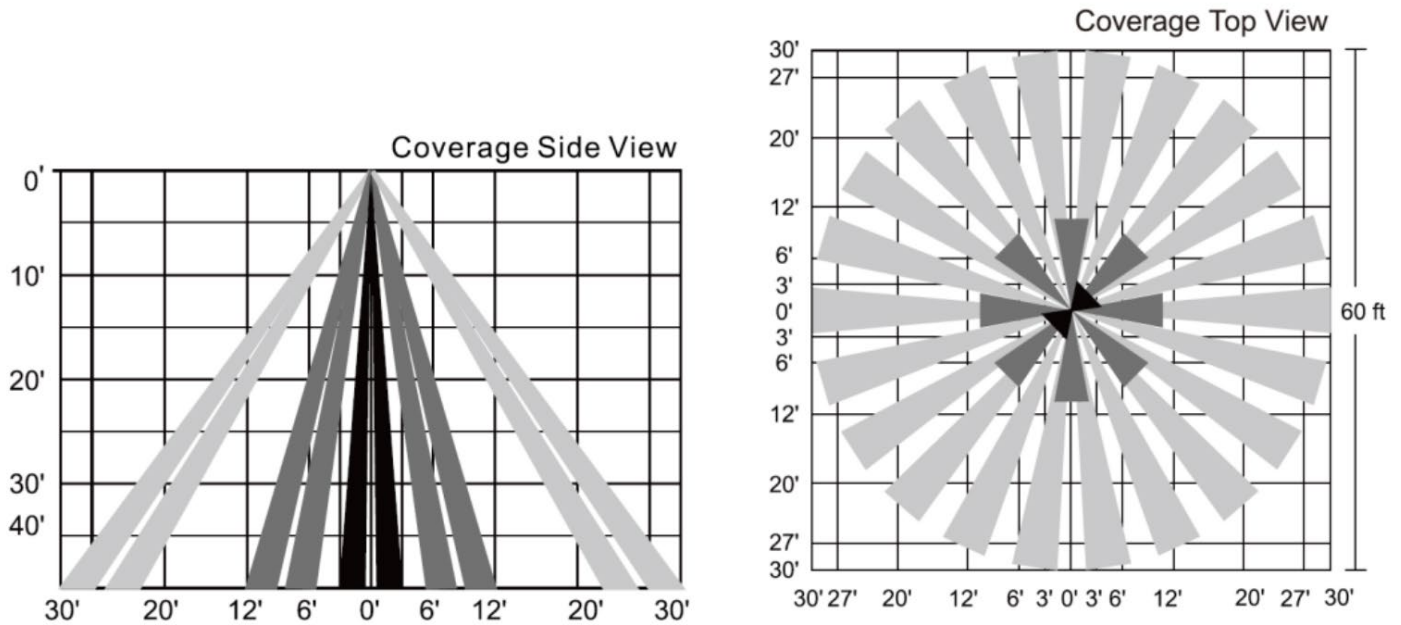

DEFAULT SENSOR SETTINGS					
BRIGHTNESS	SENSITIVITY	HOLDTIME	DAYLIGHT SENSOR	STAND-BY DIM	STAND-BY TIME
100%	100%	5 minutes	Disabled	DIM: 30%	60 minutes

RC100 REMOTE SPECIFICATIONS

FEATURES

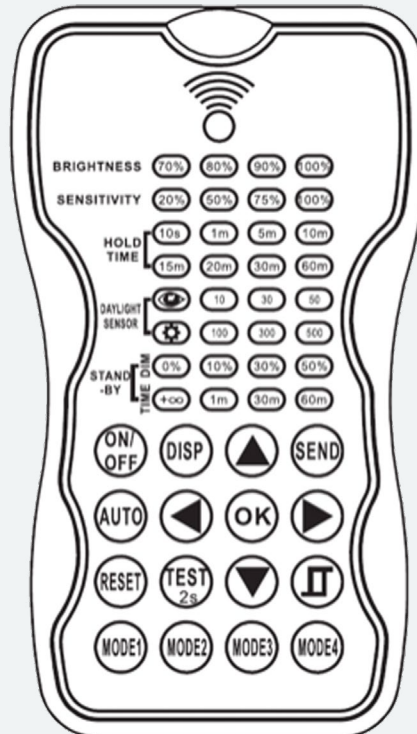

BRIGHTNESS:
Sets the highest light fixture brightness when motion is detected.

SENSITIVITY:
Sets the sensitivity to which the sensor will detect motion.

HOLD TIME:
The time the light fixture will remain at the brightness setting after it detects motion..

DAYLIGHT SENSOR:
The lux setting that the light fixture will turn on/off. If the ambient lux is more than the defined lux setting, the fixture & sensor function will turn off and remain off until the ambient lux is below the setting. To disable the lux sensor, select the SUN icon. To set the lux to match current room conditions, select the EYE icon.

STAND-BY DIM:
The Dim level that the light fixture will dim down after the Hold Time has expired.

To disable dimming and only have ON/OFF, select the 0% icon.

STAND-BY TIME:
The time the light fixture will remain in the dim down state before it shuts off. To disable the light from shutting off, select the INFINITY icon.

RC100 REMOTE CONTROL SPECIFICATION

Power Supply	2 x AAA 1.5V Batteries
Communication Protocol	940 nm Infrared Tx & Rx
Communication Range	Up to 15m (50 ft)
Operating Temp.	0 °C to 50°C (32°F to 122°F)
Dimensions	123x70x20.3mm (4.84"x2.76"x0.8")

KEY	FUNCTION
-----	----------



Light fixture will be set to permanently stay ON or OFF. Must press AUTO button to go back to sensor mode.



Displays the current remote-control parameters.



Navigate through the remote-control parameters and sets them to the desired settings.

NOTE: These settings are not yet set on the light fixture sensor. The remote needs to be pointed at the light fixture sensor, and the SEND button needs to be pushed.



Uploads the selected remote-control parameters to the light fixture sensor. The light fixture will turn on and off as confirmation the new settings have been set.



Light fixture sensor is set to sensor mode with the last sent parameters. This must be pressed to exit the ON/OFF setting.



Resets the light fixture sensor parameters. Default Settings

BRIGHTNESS	SENSITIVITY	HOLDTIME	DAYLIGHT SENSOR	STAND-BY DIM	STAND-BY TIME
100%	100%	5 minutes	Disabled	DIM: 30%	60 minutes



For Testing sensitivity only. The Standby period and daylight sensor are disabled in this mode. Must press AUTO button to go back to sensor mode.



Photocell Function: If this function is turned on, it is set to a specific lux setting (10, 30, 50, 100, 300, 500). When the lux level exceeds this setting, the sensor will wait and monitor for 1 minute to confirm the lux level is not temporary. After 1 minute, the lights will turn off even when the space is occupied. When the lux level goes below this setting, the light will turn on and remain on without any detected motion. This feature is disabled by default and is intended for outdoor use only.

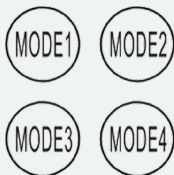

Four modes are available with pre-set parameters. Any mode can be customized by following the steps below:

1. Select mode 1, 2, 3, or 4.
2. press the ARROW BUTTONS to choose the new parameters.
3. Select OK to confirm the new settings on that mode.

NOTE: These settings are not yet set on the light fixture sensor. The remote needs to be pointed at the light fixture sensor, and the SEND button needs to be pushed.

NOTE: Modes 2, 3, and 4 all have the same default settings. See instructions to change defaults.

MODE DEFAULT SETTINGS	BRIGHTNESS	SENSITIVITY	HOLD TIME	DAYLIGHT SENSOR	STAND-BY DIM	STAND-BY TIME
	100%	100%	5 minutes	Disabled	DIM: 30%	Disabled

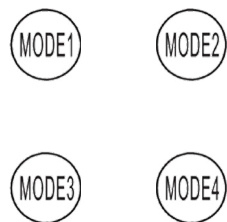

		70%	20%	10 seconds	Disabled	0%	Disabled
--	--	-----	-----	------------	----------	----	----------

HELIX2-LED240-B-4K-T2-DIM
MOUNTED AT 24 FEET

Lumens 134462.2 Maximum Calculated Value 17.55 Fc

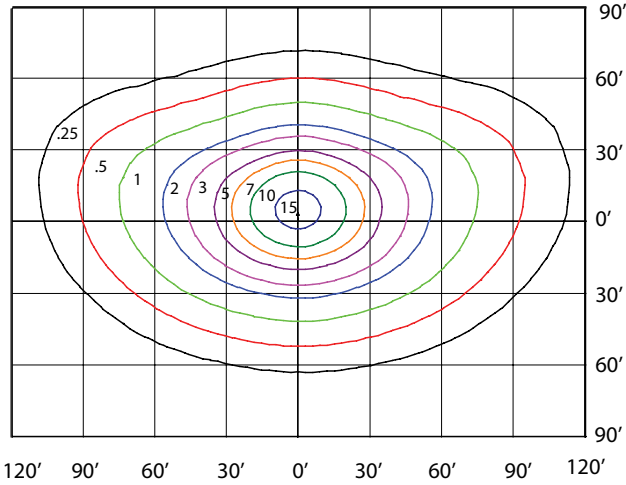

HELIX2-LED240-B-4K-T3-DIM
MOUNTED AT 24 FEET

Lumens 35006 Maximum Calculated Value 16.69 Fc

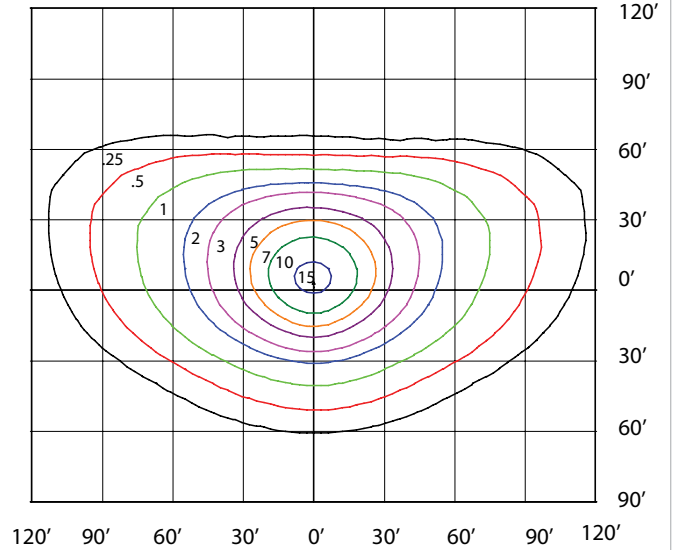

HELIX2-LED240-B-4K-T4-DIM
MOUNTED AT 24 FEET

Lumens 34169.4 Maximum Calculated Value 12.26 Fc

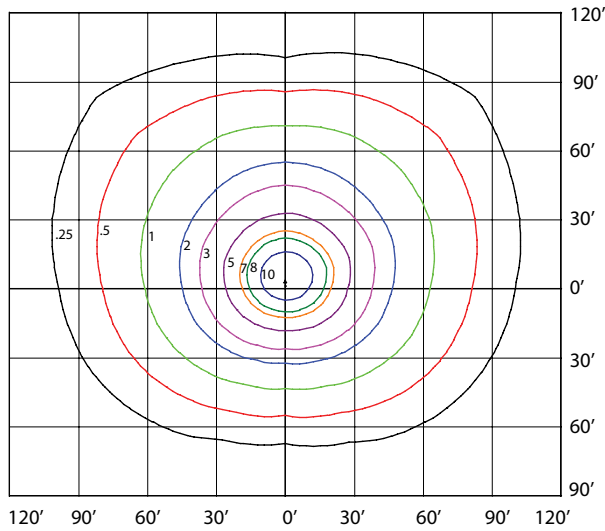

HELIX1-LED100-B-4K-T5-DIM
MOUNTED AT 20 FEET

Lumens 13075.6 Maximum Calculated Value 5.07 Fc

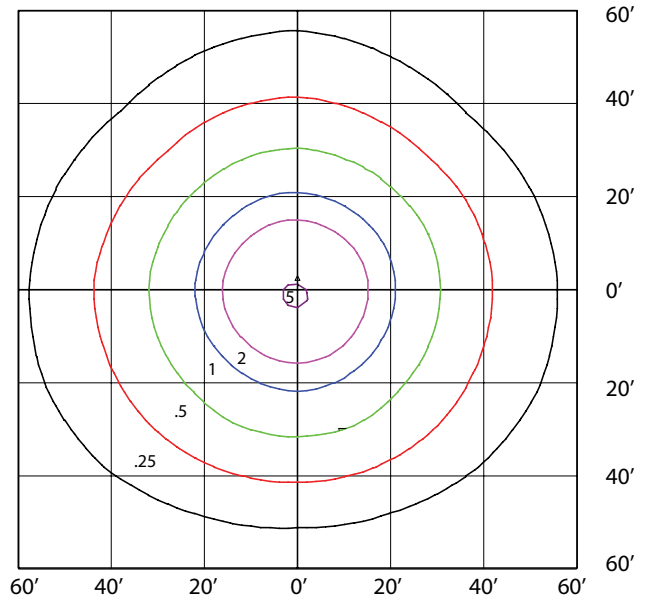

ORDERING GUIDE:

HELIX2	LED240	DIM						
Fixture	Wattage	Voltage	Color Temp.	Beam	Options	Finish	Dimming	Controls
	LED240	B- 120-277V*	3K - 3000K	T2 - Type 2	BLANK	BRZ - Bronze*	DIM - 0-10V Dimming	BLANK
		C - 347V	4K - 4000K*	T3 - Type 3	HCO - House Cutoff**	CC - Custom Color		DMS - Dimming PIR Motion Sensor
			5K - 5000K*	T4 - Type 4	SCO - Side Cutoff**			7PIN - 7 PIN Receptacle For Smart Control Systems
				T5 - Type 5				PC - Twist Lock
				T3R - Type III Distribution Rotated Right				
				T3L - Type III Distribution Rotated Left				
				T4R - Type IV Distribution Rotated Right				
				T4L - Type IV Distribution Rotated Left				
				T2R - Type II Distribution Rotated Right				
				T2L - Type II Distribution Rotated Left				

* Standard Configuration

**On-site assembly required for the installation of HCO/SCO.
Housing will come with pre-drilled holes.

Note: HCO/SCO with hardware will be shipped in separate packaging
At least one remote per order is needed with DMS control

Ordering Guide For Accessories

Check the items that you wish to order:

- 020013 HELIX2 YOKE MOUNT BRZ
- 020010 HELIX1/2 DIRECT MOUNT F/ROUND AND SQUARE POLE BRZ
- 020011 HELIX1/2 TRUNNION MOUNT BRZ
- 020009 HELIX1/2 SLIP FITTER BRZ
- 087016 RC-100 MOTION SENSOR REMOTE CONTROL