



CCM-LED

Post Top LED Area Light



Applications:
Office complexes, Campuses, Parks, Townhouses & Walkways



DESCRIPTION:

The Coachman Series has a traditional, architectural look with the latest LED technology including options for beam distributions and lumen adjustability in an easy-to-install design.

FEATURES:

Construction

Cast Aluminum housing with f1 rated UV resistant clear/frosted lens. Spun aluminum reflector for widespread, even illumination.

Driver

Driver has Short Circuit & Open Circuit Protection and temperature foldback. Temperature foldback circuit reduces the output current to ensure that the LED temperature does not exceed the set value, protecting the LED from failure. Driver complies with UL8750, Class 2 output. Electromagnetic Compliance - FCC Title 47 Part 15 Class A.

Optics

Available in T3, T4 or T5 beam distributions. Optics are rated IP65.

Mounting

Mounts a 2-3/8" to 3" OD vertical tenon. Custom pole adaptor options available. Fixture can also be wall mounted through a Decorative Wall Mount bracket sold separately.

Easy Installation

Easy opening of the top of the fixture to access lumen adjustable switch, maintenance purpose.

Finish

Corrosion resistant polyester powder paint. Sandtex Black is standard. Custom Colours available.

Lumen Adjustable Option

A rotary switch for lumen adjustment is a factory installed option. To access the switch, Installer needs to open the top of the fixture. There are options for 3 switch settings as shown on the right:

SPECIFICATIONS*	CCM-LED41	CCM-LED81	CCM-LED110
Watts	41.4	72.5	99.7
Lumens	4877.4	8091.2	10494.9
Efficacy (Lm/W)	117.9	111.6	105.2
Total Harmonic Distortion	11.7		5.2
B-U-G		3-3-3	
Colour Temp		3000K/4000K/5000K	
Power Factor		0.99	
Voltage		120-277, 347	
Beam Distribution		T3, T4, T5	
LED Life @ 100,000 Hours		88%	
Finish		Sandtex Black, Custom Colours	
Housing Details		Die Cast Aluminum	
Lens Details		f1 Rated UV resistant Clear/Frosted Polycarbonate Lens	
Mounting		3" Post Top Mount, Wall Mount with decorative arm	
Operating Temp.		-40°C to +40°C	
Certifications		UL 1598, Wet Location, 5 Year Warranty, DLC Standard, IP66, 3G	
Factory Installed Options		Lumen Adjustment Switch, Photocell, 3/7 PIN Receptacle, Frosted Lens, 90/180° House Side Cut Off Options (not DLC listed), 10 kV Surge Protection	
Options Sold Separately		Decorative Wall Mount Arm, Pole Adaptors	
Vibration		3G rated per ANSI C136.31-2010 standard	

* Specs shown are for 120-277V/ 5K/T5 option.
For detailed specs of other models, please refer pages 5 to 8.

LUMEN ADJUSTABLE SETTINGS:

CCM-LED81A41 (ADJUSTABLE 72.5W/60W/41.4W)			
WATTS	40	60	73
LUMENS	4462	6693	8091
CCM-LED110A81 (ADJUSTABLE 99.7W/90W/72.5W)			
WATTS	80	90	110
LUMENS	8419	9472	10495
CCM-LED110A41 (ADJUSTABLE 99.7W/72.5W/41.4W)			
WATTS	40	80	110
LUMENS	4462	8419	10495

DIMENSIONS:

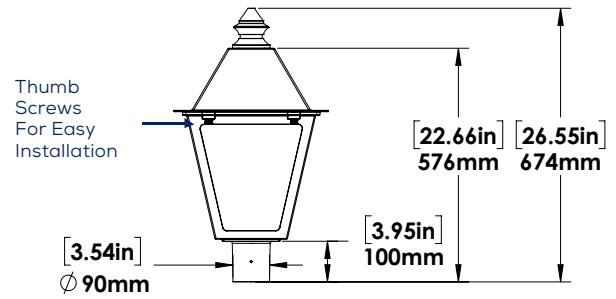
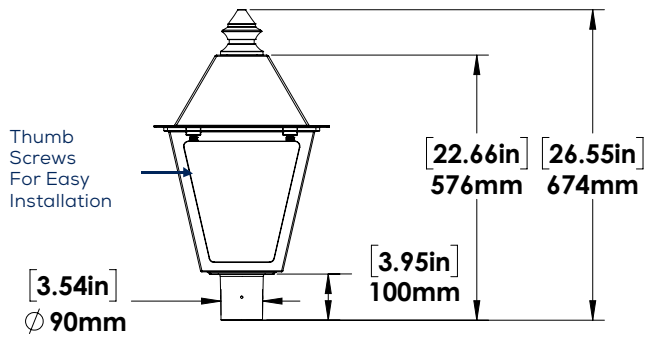
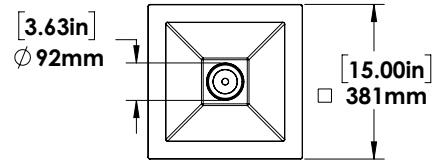
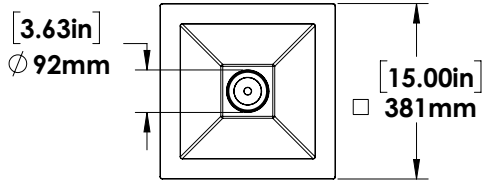

With Decorative Top (Standard)

With Photocell (Optional)

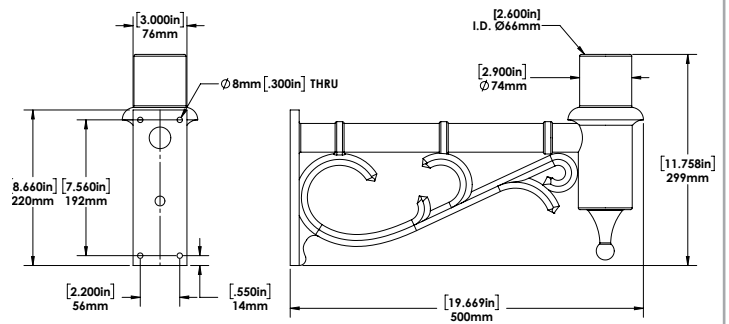

Decorative Arm

CCM-LED41

AMPERAGE DRAW & SURGE PROTECTION							
	CURRENT (A)					SURGE PROTECTION (kV)	
	120V	208V	240V	277V	347V	120-277V	347V
CCM-LED41	0.35A	0.21A	0.18A	0.16A	0.13A	2.50	6.00
WEIGHT (lbs)							
CCM-LED41	24.5						
EPA							
CCM-LED41	2.78						
LUMEN MAINTENANCE (Projections as per IES TM-21 at 25°C)							
	50,000 HRS		75,000 HRS			100,000 HRS	
	CCM-LED41	93.6%		90.8%			88.0%

CCM-LED81

AMPERAGE DRAW & SURGE PROTECTION							
	CURRENT (A)					SURGE PROTECTION (kV)	
	120V	208V	240V	277V	347V	120-277V	347V
CCM-LED81	0.7A	0.41A	0.35A	0.31A	0.25A	6.00	6.00
WEIGHT (lbs)							
CCM-LED81	24.5						
EPA							
CCM-LED81	2.78						
LUMEN MAINTENANCE (Projections as per IES TM-21 at 25°C)							
	50,000 HRS		75,000 HRS			100,000 HRS	
	CCM-LED81	93.6%		90.8%			88.0%

CCM-LED110

AMPERAGE DRAW & SURGE PROTECTION							
	CURRENT (A)					SURGE PROTECTION (kV)	
	120V	208V	240V	277V	347V	120-277V	347V
CCM-LED110	0.97A	0.56A	0.49A	0.42A	0.25A	6.00	
WEIGHT (lbs)							
CCM-LED110	24.5						
EPA							
CCM-LED110	2.78						
LUMEN MAINTENANCE (Projections as per IES TM-21 at 25°C)							
	50,000 HRS		75,000 HRS			100,000 HRS	
	CCM-LED110	93.6%		90.8%			88.0%

CCM-LED41-B-4K-T3-DIM-CL
MOUNTED AT 12 FEET

Total Lumens = 4886 Mounting 12 Feet Maximum Calculated Value = 6.01 Fc

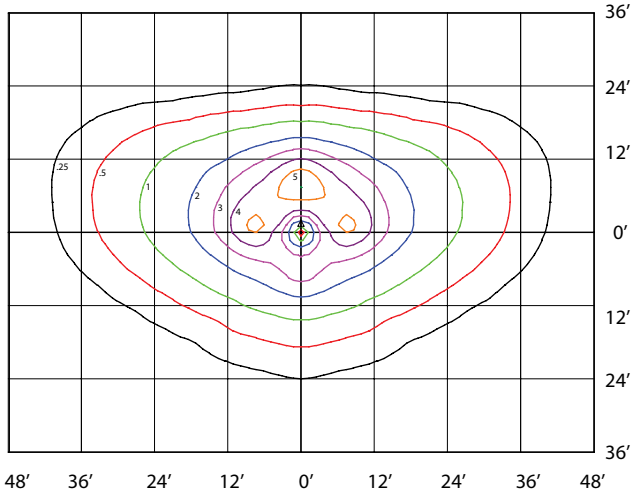

CCM-LED41-B-4K-T4-DIM-CL
MOUNTED AT 12 FEET

Total Lumens = 4848 Mounting 12 Feet Maximum Calculated Value = 4.89 Fc

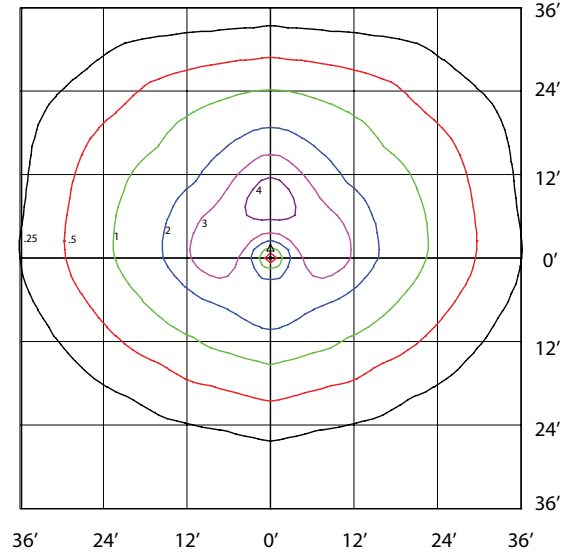

CCM-LED41-B-4K-T5-DIM-CL
MOUNTED AT 12 FEET

Total Lumens = 4926 Mounting 12 Feet Maximum Calculated Value = 3.35 Fc

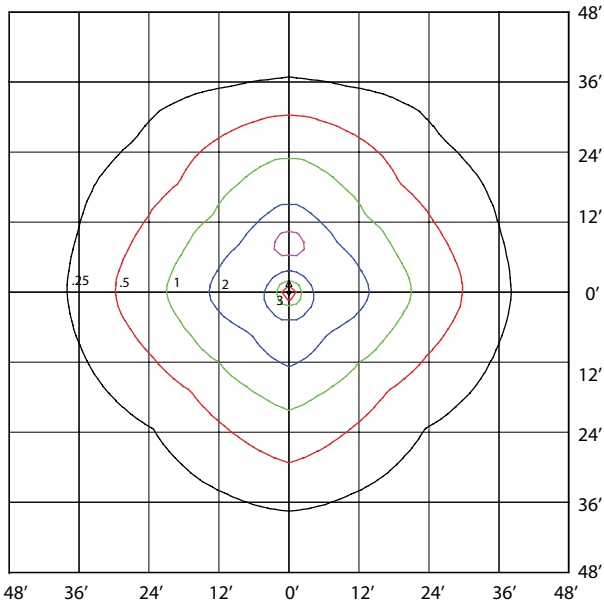

CCM-LED81-B-4K-T3-DIM-CL
MOUNTED AT 16 FEET

Total Lumens = 8402 Mounting 16 Feet Maximum Calculated Value = 5.81 Fc

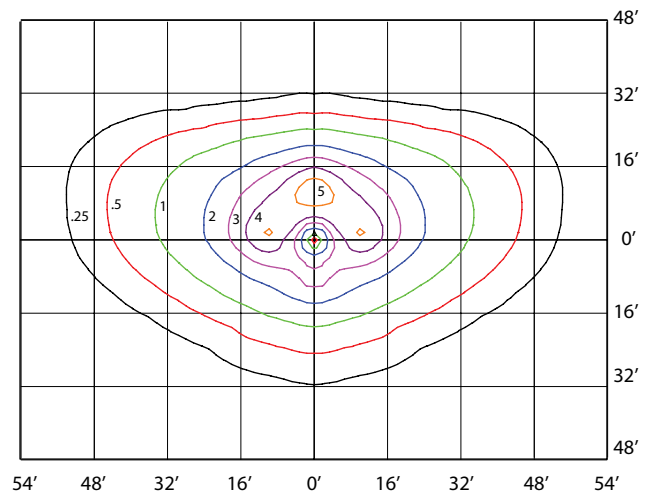

CCM-LED81-B-4K-T4-DIM-CL
MOUNTED AT 16 FEET

Total Lumens = 8535 Mounting 16 Feet Maximum Calculated Value = 4.84 Fc

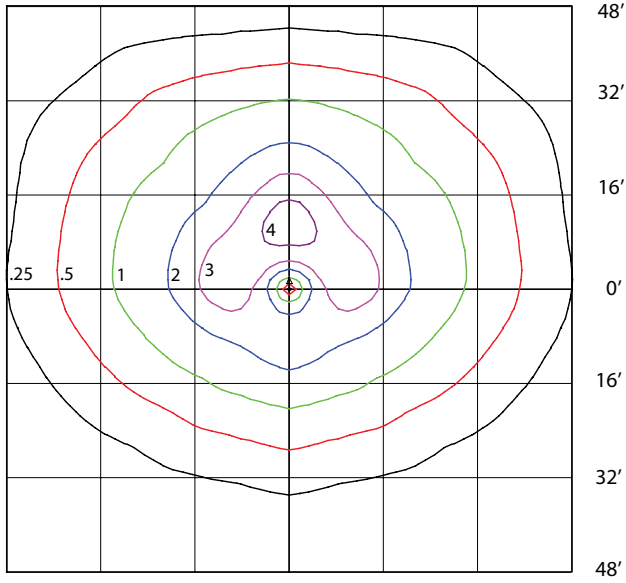

CCM-LED81-B-4K-T5-DIM-CL
MOUNTED AT 16 FEET

Total Lumens = 8172 Mounting 16 Feet Maximum Calculated Value = 3.13 Fc

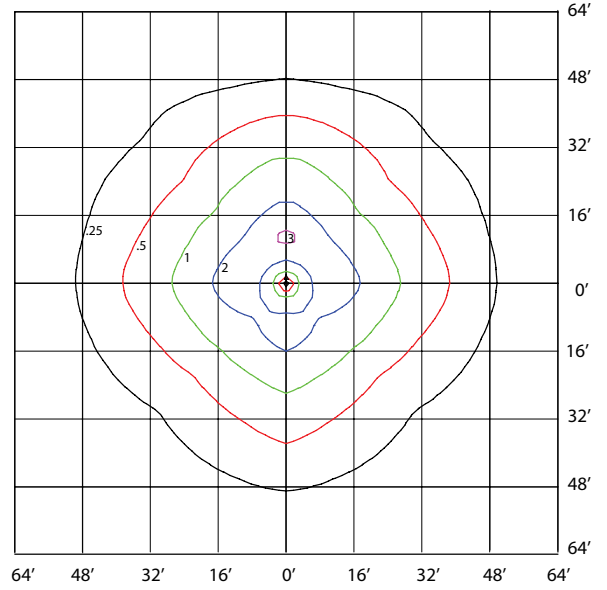

CCM-LED110-B-4K-T3-DIM-CL
MOUNTED AT 20 FEET

Total Lumens = 10898 Mounting 20 Feet Maximum Calculated Value = 4.79 Fc

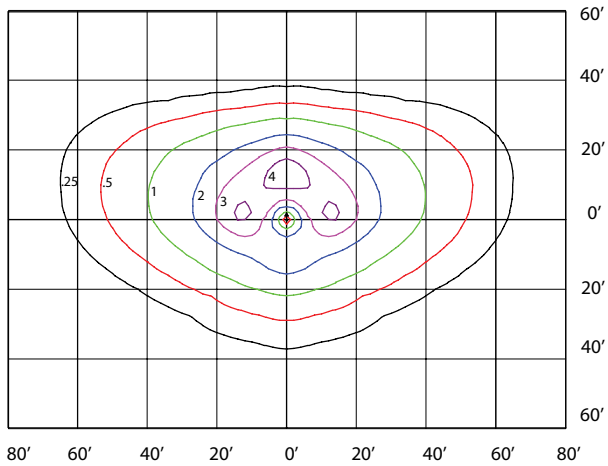

CCM-LED110-B-4K-T4-DIM-CL
MOUNTED AT 20 FEET

Total Lumens = 10852 Mounting 20 Feet Maximum Calculated Value = 3.99 Fc

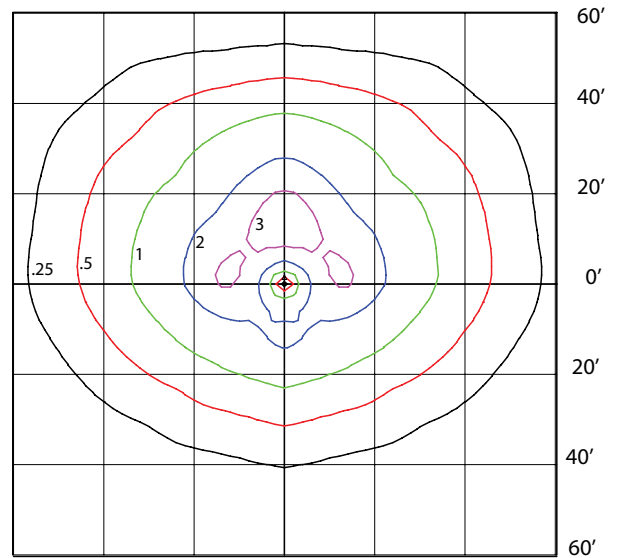

CCM-LED110-B-4K-T5-DIM-CL
MOUNTED AT 20 FEET

Total Lumens = 10600

Mounting 20 Feet

Maximum Calculated Value = 2.62 Fc

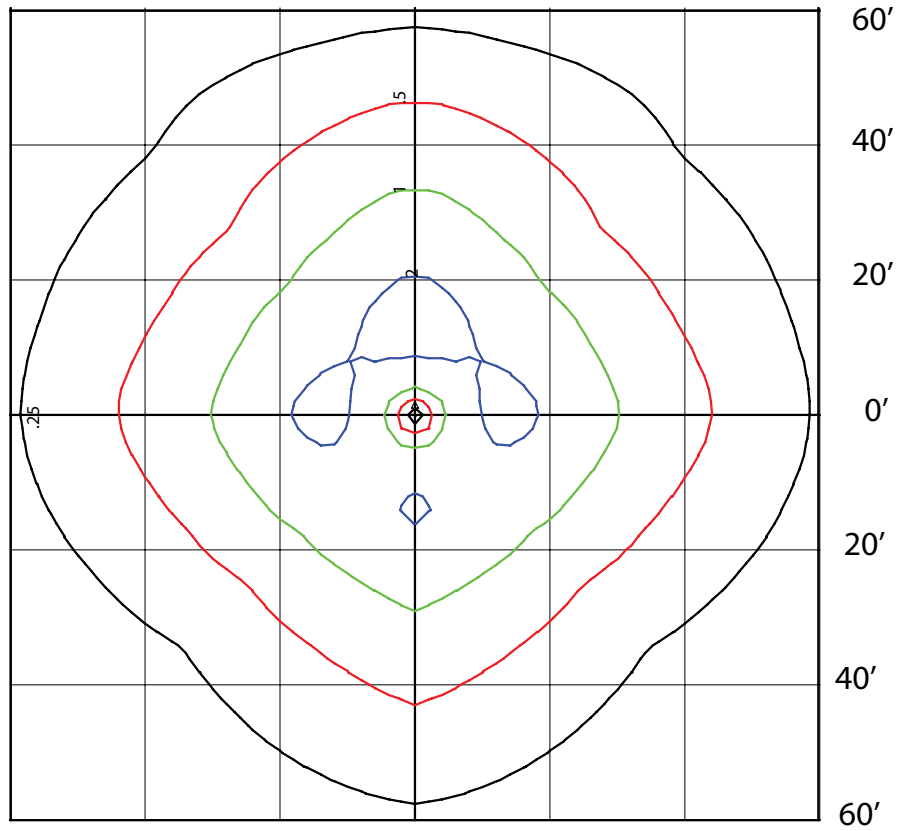

ORDERING GUIDE:

CCM		DIM						
	Wattage	Voltage	Colour Temp.	Optics	Optional Cut-Off	Paint Finish	Dimming	Controls
	LED41	B - 120-277V*	3K - 3000K	T3 - Type III	HCO90*** - 90° House Side Cut-Off (not DLC listed)	SBK - Sandtex Black*	DIM - 0 -10V Dimming*	PC-Photocell
	LED81	C - 347V	4K - 4000K	T4 - Type IV		CC - Custom Colour		3PIN - 3 Pin Receptacle w/ Shorting Cap
	LED81A41		5K - 5000K*	T5 - Type V*				
	LED110				HCO180*** - 180° House Side Cut-Off (not DLC listed)			7PIN - 7 Pin Receptacle w/ Shorting Cap
	LED110A41							
	LED110A81							

WATTAGE MAPPING TABLE**

Lens	Options
CL - Clear Lens*	SP10 - 10 kV Surge Protection
FR - Frosted Lens (not DLC listed)	

LED41	41.4W
LED81	72.5W
LED81A41	41.4W/60W/73W
LED110	99.7W
LED110A41	41.4W/72.5W/99.7W
LED110A81	72.5W/90W/99.7W

*Standard Configuration

** These wattages are for B/T5/5K

*** HCO option is factory installed only

ORDERING GUIDE FOR ACCESSORIES

Options Sold Separately

Check the items that you wish to order:

096801 - DECORATIVE ARM 3”R BLACK

CCM-LED41

SPECIFICATIONS							
Model Number	Voltage (V)	Power (W)	Light Output (lm)	Efficacy (lm/W)	THD (%)	PF	CCT (K)
CCM-LED41-B-3K-T3-XXX-DIM-CL-[PC,3PIN,7PIN,Blank]	120-277	41	4854	117.3	11.7	0.985	2900
CCM-LED41-B-4K-T3-XXX-DIM-CL-[PC,3PIN,7PIN,Blank]	120-277	41	4855	117.3	11.7	0.985	4000
CCM-LED41-B-5K-T3-XXX-DIM-CL-[PC,3PIN,7PIN,Blank]	120-277	41	4867	117.6	11.7	0.985	4900
CCM-LED41-B-3K-T4-XXX-DIM-CL-[PC,3PIN,7PIN,Blank]	120-277	41	4895	118.3	11.7	0.985	2900
CCM-LED41-B-4K-T4-XXX-DIM-CL-[PC,3PIN,7PIN,Blank]	120-277	41	4822	116.5	11.7	0.985	4000
CCM-LED41-B-5K-T4-XXX-DIM-CL-[PC,3PIN,7PIN,Blank]	120-277	41	4895	118.3	11.7	0.985	4900
CCM-LED41-B-3K-T5-XXX-DIM-CL-[PC,3PIN,7PIN,Blank]	120-277	41	4852	117.3	11.7	0.985	2900
CCM-LED41-B-4K-T5-XXX-DIM-CL-[PC,3PIN,7PIN,Blank]	120-277	41	4877	117.9	11.7	0.985	4000
CCM-LED41-B-5K-T5-XXX-DIM-CL-[PC,3PIN,7PIN,Blank]	120-277	41	4952	119.7	11.7	0.985	4900
CCM-LED41-C-3K-T3-XXX-DIM-CL-[PC,3PIN,7PIN,Blank]	347	41	4852	117.3	11.7	0.985	2900
CCM-LED41-C-4K-T3-XXX-DIM-CL-[PC,3PIN,7PIN,Blank]	347	41	4854	117.3	11.7	0.985	4000
CCM-LED41-C-5K-T3-XXX-DIM-CL-[PC,3PIN,7PIN,Blank]	347	41	4865	117.6	11.7	0.985	4900
CCM-LED41-C-3K-T4-XXX-DIM-CL-[PC,3PIN,7PIN,Blank]	347	41	4925	119.0	11.7	0.985	2900
CCM-LED41-C-4K-T4-XXX-DIM-CL-[PC,3PIN,7PIN,Blank]	347	41	4895	118.3	11.7	0.985	4000
CCM-LED41-C-5K-T4-XXX-DIM-CL-[PC,3PIN,7PIN,Blank]	347	41	4968	120.1	11.7	0.985	4900
CCM-LED41-C-3K-T5-XXX-DIM-CL-[PC,3PIN,7PIN,Blank]	347	41	4781	115.5	11.7	0.985	2900
CCM-LED41-C-4K-T5-XXX-DIM-CL-[PC,3PIN,7PIN,Blank]	347	41	4804	116.1	11.7	0.985	4000
CCM-LED41-C-5K-T5-XXX-DIM-CL-[PC,3PIN,7PIN,Blank]	347	41	4877	117.9	11.7	0.985	4900

CCM-LED81

SPECIFICATIONS							
Model Number	Voltage (V)	Power (W)	Light Output (lm)	Efficacy (lm/W)	THD (%)	PF	CCT (K)
CCM-LED81-B-3K-T3-XXX-DIM-CL-[PC,3PIN,7PIN,Blank]	120-277	75	8305	111.0	5.2	0.998	3000
CCM-LED81-B-4K-T3-XXX-DIM-CL-[PC,3PIN,7PIN,Blank]	120-277	75	8349	111.6	5.2	0.998	4000
CCM-LED81-B-5K-T3-XXX-DIM-CL-[PC,3PIN,7PIN,Blank]	120-277	75	8359	111.7	5.2	0.998	4900
CCM-LED81-B-3K-T4-XXX-DIM-CL-[PC,3PIN,7PIN,Blank]	120-277	75	8364	111.8	5.2	0.998	3000
CCM-LED81-B-4K-T4-XXX-DIM-CL-[PC,3PIN,7PIN,Blank]	120-277	75	8490	113.5	5.2	0.998	4000
CCM-LED81-B-5K-T4-XXX-DIM-CL-[PC,3PIN,7PIN,Blank]	120-277	75	8483	113.4	5.2	0.998	4900
CCM-LED81-B-3K-T5-XXX-DIM-CL-[PC,3PIN,7PIN,Blank]	120-277	73	8044	110.9	5.2	0.998	3000
CCM-LED81-B-4K-T5-XXX-DIM-CL-[PC,3PIN,7PIN,Blank]	120-277	73	8091	111.6	5.2	0.998	4000
CCM-LED81-B-5K-T5-XXX-DIM-CL-[PC,3PIN,7PIN,Blank]	120-277	73	8176	112.7	5.2	0.998	4900
CCM-LED81-C-3K-T3-XXX-DIM-CL-[PC,3PIN,7PIN,Blank]	347	75	8303	111.0	5.2	0.998	3000
CCM-LED81-C-4K-T3-XXX-DIM-CL-[PC,3PIN,7PIN,Blank]	347	75	8303	111.0	5.2	0.998	4000
CCM-LED81-C-5K-T3-XXX-DIM-CL-[PC,3PIN,7PIN,Blank]	347	75	8338	111.4	5.2	0.998	4900
CCM-LED81-C-3K-T4-XXX-DIM-CL-[PC,3PIN,7PIN,Blank]	347	75	8451	112.9	5.2	0.998	3000
CCM-LED81-C-4K-T4-XXX-DIM-CL-[PC,3PIN,7PIN,Blank]	347	75	8577	114.6	5.2	0.998	4000
CCM-LED81-C-5K-T4-XXX-DIM-CL-[PC,3PIN,7PIN,Blank]	347	75	8610	115.1	5.2	0.998	4900
CCM-LED81-C-3K-T5-XXX-DIM-CL-[PC,3PIN,7PIN,Blank]	347	73	8108	111.8	5.2	0.998	3000

Model Number	Voltage (V)	Power (W)	Light Output (lm)	Efficacy (lm/W)	THD (%)	PF	CCT (K)
CCM-LED81-C-4K-T5-XXX-DIM-CL-[PC,3PIN,7PIN,Blank]	347	73	8047	110.9	5.2	0.998	4000
CCM-LED81-C-5K-T5-XXX-DIM-CL-[PC,3PIN,7PIN,Blank]	347	73	8092	111.6	5.2	0.998	4900

CCM-LED81A41

SPECIFICATIONS							
Model Number	Voltage (V)	Power (W)	Light Output (lm)	Efficacy (lm/W)	THD (%)	PF	CCT (K)
CCM-LED81A41-B-3K-T3-XXX-DIM-CL-[PC,3PIN,7PIN,Blank]	120-277	75	8305	111.0	5.2	0.998	3000
CCM-LED81A41-B-4K-T3-XXX-DIM-CL-[PC,3PIN,7PIN,Blank]	120-277	75	8349	111.6	5.2	0.998	4000
CCM-LED81A41-B-5K-T3-XXX-DIM-CL-[PC,3PIN,7PIN,Blank]	120-277	75	8359	111.7	5.2	0.998	4900
CCM-LED81A41-B-3K-T4-XXX-DIM-CL-[PC,3PIN,7PIN,Blank]	120-277	75	8364	111.8	5.2	0.998	3000
CCM-LED81A41-B-4K-T4-XXX-DIM-CL-[PC,3PIN,7PIN,Blank]	120-277	75	8490	113.5	5.2	0.998	4000
CCM-LED81A41-B-5K-T4-XXX-DIM-CL-[PC,3PIN,7PIN,Blank]	120-277	75	8483	113.4	5.2	0.998	4900
CCM-LED81A41-B-3K-T5-XXX-DIM-CL-[PC,3PIN,7PIN,Blank]	120-277	73	8044	110.9	5.2	0.998	3000
CCM-LED81A41-B-4K-T5-XXX-DIM-CL-[PC,3PIN,7PIN,Blank]	120-277	73	8091	111.6	5.2	0.998	4000
CCM-LED81A41-B-5K-T5-XXX-DIM-CL-[PC,3PIN,7PIN,Blank]	120-277	73	8176	112.7	5.2	0.998	4900
CCM-LED81A41-C-3K-T3-XXX-DIM-CL-[PC,3PIN,7PIN,Blank]	347	75	8303	111.0	5.2	0.998	3000
CCM-LED81A41-C-4K-T3-XXX-DIM-CL-[PC,3PIN,7PIN,Blank]	347	75	8303	111.0	5.2	0.998	4000
CCM-LED81A41-C-5K-T3-XXX-DIM-CL-[PC,3PIN,7PIN,Blank]	347	75	8338	111.4	5.2	0.998	4900
CCM-LED81A41-C-3K-T4-XXX-DIM-CL-[PC,3PIN,7PIN,Blank]	347	75	8451	112.9	5.2	0.998	3000
CCM-LED81A41-C-4K-T4-XXX-DIM-CL-[PC,3PIN,7PIN,Blank]	347	75	8577	114.6	5.2	0.998	4000
CCM-LED81A41-C-5K-T4-XXX-DIM-CL-[PC,3PIN,7PIN,Blank]	347	75	8610	115.1	5.2	0.998	4900
CCM-LED81A41-C-3K-T5-XXX-DIM-CL-[PC,3PIN,7PIN,Blank]	347	73	8108	111.8	5.2	0.998	3000
CCM-LED81A41-C-4K-T5-XXX-DIM-CL-[PC,3PIN,7PIN,Blank]	347	73	8047	110.9	5.2	0.998	4000
CCM-LED81A41-C-5K-T5-XXX-DIM-CL-[PC,3PIN,7PIN,Blank]	347	73	8092	111.6	5.2	0.998	4900

CCM-LED110

SPECIFICATIONS							
Model Number	Voltage (V)	Power (W)	Light Output (lm)	Efficacy (lm/W)	THD (%)	PF	CCT (K)
CCM-LED110-B-3K-T3-XXX-DIM-CL-[PC,3PIN,7PIN,Blank]	120-277	103	10708	104.7	5.2	0.998	3000
CCM-LED110-B-4K-T3-XXX-DIM-CL-[PC,3PIN,7PIN,Blank]	120-277	103	10829	105.3	5.2	0.998	4000
CCM-LED110-B-5K-T3-XXX-DIM-CL-[PC,3PIN,7PIN,Blank]	120-277	103	10886	105.8	5.2	0.998	4900
CCM-LED110-B-3K-T4-XXX-DIM-CL-[PC,3PIN,7PIN,Blank]	120-277	101	10640	105.3	5.3	0.997	3000
CCM-LED110-B-4K-T4-XXX-DIM-CL-[PC,3PIN,7PIN,Blank]	120-277	101	10794	106.9	5.3	0.997	4000
CCM-LED110-B-5K-T4-XXX-DIM-CL-[PC,3PIN,7PIN,Blank]	120-277	101	10956	108.5	5.3	0.997	4900
CCM-LED110-B-3K-T5-XXX-DIM-CL-[PC,3PIN,7PIN,Blank]	120-277	100	10440	104.7	5.2	0.998	3000
CCM-LED110-B-4K-T5-XXX-DIM-CL-[PC,3PIN,7PIN,Blank]	120-277	100	10495	105.2	5.2	0.998	4000
CCM-LED110-B-5K-T5-XXX-DIM-CL-[PC,3PIN,7PIN,Blank]	120-277	100	10550	105.8	5.2	0.998	4900
CCM-LED110-C-3K-T3-XXX-DIM-CL-[PC,3PIN,7PIN,Blank]	347	103	10775	104.7	4.0	0.9979	3000

Model Number	Voltage (V)	Power (W)	Light Output (lm)	Efficacy (lm/W)	THD (%)	PF	CCT (K)
CCM-LED110-C-4K-T3-XXX-DIM-CL-[PC,3PIN,7PIN,Blank]	347	103	10804	105.0	4.0	0.9979	4000
CCM-LED110-C-5K-T3-XXX-DIM-CL-[PC,3PIN,7PIN,Blank]	347	103	10833	105.3	4.0	0.9979	4900
CCM-LED110-C-3K-T4-XXX-DIM-CL-[PC,3PIN,7PIN,Blank]	347	104	11119	106.9	4.0	0.9979	3000
CCM-LED110-C-4K-T4-XXX-DIM-CL-[PC,3PIN,7PIN,Blank]	347	104	11286	108.5	4.0	0.9979	4000
CCM-LED110-C-5K-T4-XXX-DIM-CL-[PC,3PIN,7PIN,Blank]	347	104	11455	110.1	4.0	0.9979	4900
CCM-LED110-C-3K-T5-XXX-DIM-CL-[PC,3PIN,7PIN,Blank]	347	101	10740	106.3	7.0	0.997	3000
CCM-LED110-C-4K-T5-XXX-DIM-CL-[PC,3PIN,7PIN,Blank]	347	101	10688	105.8	7.0	0.997	4000
CCM-LED110-C-5K-T5-XXX-DIM-CL-[PC,3PIN,7PIN,Blank]	347	104	10952	105.3	4.0	0.9979	4900

CCM-LED110A41

SPECIFICATIONS

Model Number	Voltage (V)	Power (W)	Light Output (lm)	Efficacy (lm/W)	THD (%)	PF	CCT (K)
CCM-LED110A41-B-3K-T3-XXX-DIM-CL-[PC,3PIN,7PIN,Blank]	120-277	103	10708	104.7	5.2	0.998	3000
CCM-LED110A41-B-4K-T3-XXX-DIM-CL-[PC,3PIN,7PIN,Blank]	120-277	103	10829	105.3	5.2	0.998	4000
CCM-LED110A41-B-5K-T3-XXX-DIM-CL-[PC,3PIN,7PIN,Blank]	120-277	103	10886	105.8	5.2	0.998	4900
CCM-LED110A41-B-3K-T4-XXX-DIM-CL-[PC,3PIN,7PIN,Blank]	120-277	101	10640	105.3	5.3	0.997	3000
CCM-LED110A41-B-4K-T4-XXX-DIM-CL-[PC,3PIN,7PIN,Blank]	120-277	101	10794	106.9	5.3	0.997	4000
CCM-LED110A41-B-5K-T4-XXX-DIM-CL-[PC,3PIN,7PIN,Blank]	120-277	101	10956	108.5	5.3	0.997	4900
CCM-LED110A41-B-3K-T5-XXX-DIM-CL-[PC,3PIN,7PIN,Blank]	120-277	100	10440	104.7	5.2	0.998	3000
CCM-LED110A41-B-4K-T5-XXX-DIM-CL-[PC,3PIN,7PIN,Blank]	120-277	100	10495	105.2	5.2	0.998	4000
CCM-LED110A41-B-5K-T5-XXX-DIM-CL-[PC,3PIN,7PIN,Blank]	120-277	100	10550	105.8	5.2	0.998	4900
CCM-LED110A41-C-3K-T3-XXX-DIM-CL-[PC,3PIN,7PIN,Blank]	347	103	10775	104.7	4.0	0.9979	3000
CCM-LED110A41-C-4K-T3-XXX-DIM-CL-[PC,3PIN,7PIN,Blank]	347	103	10804	105.0	4.0	0.9979	4000
CCM-LED110A41-C-5K-T3-XXX-DIM-CL-[PC,3PIN,7PIN,Blank]	347	103	10833	105.3	4.0	0.9979	4900
CCM-LED110A41-C-3K-T4-XXX-DIM-CL-[PC,3PIN,7PIN,Blank]	347	104	11119	106.9	4.0	0.9979	3000
CCM-LED110A41-C-4K-T4-XXX-DIM-CL-[PC,3PIN,7PIN,Blank]	347	104	11286	108.5	4.0	0.9979	4000
CCM-LED110A41-C-5K-T4-XXX-DIM-CL-[PC,3PIN,7PIN,Blank]	347	104	11455	110.1	4.0	0.9979	4900
CCM-LED110A41-C-3K-T5-XXX-DIM-CL-[PC,3PIN,7PIN,Blank]	347	101	10740	106.3	7.0	0.997	3000
CCM-LED110A41-C-4K-T5-XXX-DIM-CL-[PC,3PIN,7PIN,Blank]	347	101	10688	105.8	7.0	0.997	4000
CCM-LED110A41-C-5K-T5-XXX-DIM-CL-[PC,3PIN,7PIN,Blank]	347	104	10952	105.3	4.0	0.9979	4900

CCM-LED110A81

SPECIFICATIONS							
Model Number	Voltage (V)	Power (W)	Light Output (lm)	Efficacy (lm/W)	THD (%)	PF	CCT (K)
CCM-LED110A81-B-3K-T3-XXX-DIM-CL-[PC,3PIN,7PIN,Blank]	120-277	103	10708	104.7	5.2	0.998	3000
CCM-LED110A81-B-4K-T3-XXX-DIM-CL-[PC,3PIN,7PIN,Blank]	120-277	103	10829	105.3	5.2	0.998	4000
CCM-LED110A81-B-5K-T3-XXX-DIM-CL-[PC,3PIN,7PIN,Blank]	120-277	103	10886	105.8	5.2	0.998	4900
CCM-LED110A81-B-3K-T4-XXX-DIM-CL-[PC,3PIN,7PIN,Blank]	120-277	101	10640	105.3	5.3	0.997	3000
CCM-LED110A81-B-4K-T4-XXX-DIM-CL-[PC,3PIN,7PIN,Blank]	120-277	101	10794	106.9	5.3	0.997	4000
CCM-LED110A81-B-5K-T4-XXX-DIM-CL-[PC,3PIN,7PIN,Blank]	120-277	101	10956	108.5	5.3	0.997	4900
CCM-LED110A81-B-3K-T5-XXX-DIM-CL-[PC,3PIN,7PIN,Blank]	120-277	100	10440	104.7	5.2	0.998	3000
CCM-LED110A81-B-4K-T5-XXX-DIM-CL-[PC,3PIN,7PIN,Blank]	120-277	100	10495	105.2	5.2	0.998	4000
CCM-LED110A81-B-5K-T5-XXX-DIM-CL-[PC,3PIN,7PIN,Blank]	120-277	100	10550	105.8	5.2	0.998	4900
CCM-LED110A81-C-3K-T3-XXX-DIM-CL-[PC,3PIN,7PIN,Blank]	347	103	10775	104.7	4.0	0.9979	3000
CCM-LED110A81-C-4K-T3-XXX-DIM-CL-[PC,3PIN,7PIN,Blank]	347	103	10804	105.0	4.0	0.9979	4000
CCM-LED110A81-C-5K-T3-XXX-DIM-CL-[PC,3PIN,7PIN,Blank]	347	103	10833	105.3	4.0	0.9979	4900
CCM-LED110A81-C-3K-T4-XXX-DIM-CL-[PC,3PIN,7PIN,Blank]	347	104	11119	106.9	4.0	0.9979	3000
CCM-LED110A81-C-4K-T4-XXX-DIM-CL-[PC,3PIN,7PIN,Blank]	347	104	11286	108.5	4.0	0.9979	4000
CCM-LED110A81-C-5K-T4-XXX-DIM-CL-[PC,3PIN,7PIN,Blank]	347	104	11455	110.1	4.0	0.9979	4900
CCM-LED110A81-C-3K-T5-XXX-DIM-CL-[PC,3PIN,7PIN,Blank]	347	101	10740	106.3	7.0	0.997	3000
CCM-LED110A81-C-4K-T5-XXX-DIM-CL-[PC,3PIN,7PIN,Blank]	347	101	10688	105.8	7.0	0.997	4000